



MBO*

Perforators, Slitters & Scores

Perf Shaft Sizes

30mm Page 1

35mm Page 1

40mm Page 5

65mm Page 5

Slitter & Score Shaft Sizes

30mm Page 6

35mm Page 6

40mm Page 7

65mm Page 7

UPDATE LTD

134 Peavey Circle, Chaska, MN 55318

1-800-229-0009

P. 952-556-5666

F. 952-556-8777

Quick tips on choosing correct blades:

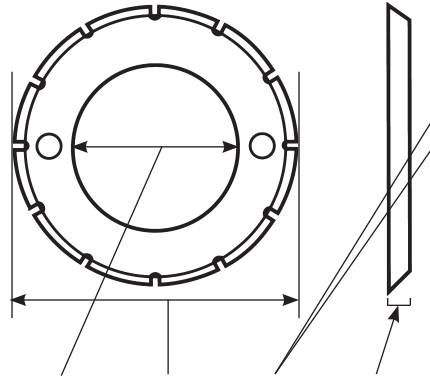

Teeth = Total number of teeth on perf
 # TPI = Number of teeth per inch
 (These are generally referred as micro perfs.)

NOTE! Lots of problems are caused by dull perfs, slitters and die blocks.

ID	OD	#Teeth	Thick
26mm	39mm	12	0.5mm
Stahl#	200-750-06-00		
Update#	SP200		

This guide is organized first by shaft size, smallest to largest...
 Then by number of teeth, fewest to most (except micro perfs).

All images in this guide are actual size for comparison.

“V” shaped tooth



- Maximizes the distance between each tooth in perfs with a low number of teeth such as 6, 8, 12 or 18.
- Increases the strength of the teeth in perfs with a high number of teeth such as 60, 72, 80 or more.
- Lower # of teeth (12-18) better for backbone on perfect bound books - sigs won't tear.

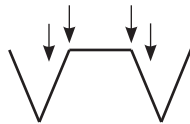

Also

If shaft is adjustable, a slightly wider perf cut can be made.

Crimping perf

- Holds sheets together temporarily.
- Used for processing zig zag folded sheets on a gather - stitcher and envelopes on a perfect binder.

Knockout (punch) perf

- Use when printed product needs perforation in the spine for adhesive binding or air relief.

Reverse Tooth

Standard



Reverse



- Assumes blades are placed on upper slitter shaft.
- Holds fold together on 16 page books.

Round Tooth

- Good for perfin multiple sheets at a time.



MBO* Perforators - 30/35mm SHAFT

30mm SHAFT

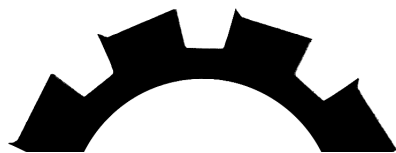

ID	OD	#Teeth	Thick
35mm	54mm	9	1.57mm
MBO#	2.0.5591.100		
Update#	KP078 - Knockout		



ID	OD	#Teeth	Thick
35mm	53mm	10	0.5mm
MBO#	2.0.5591.120		
Update#	SP278		



ID	OD	#Teeth	Thick
35mm	53mm	12	0.5mm
MBO#	2.0.5591.070		
Update#	MN888		

30mm SHAFT



ID	OD	#Teeth	Thick
35mm	53mm	15	0.5mm
MBO#	2.0.5591.030		
Update#	MN492		



ID	OD	#Teeth	Thick
	53mm	22	0.5mm
MBO#	2.0.5591.040		
Update#	SP788		



ID	OD	#Teeth	Thick
	53mm	42	0.5mm
MBO#	2.0.5591.050		
Update#	MN199		

30mm SHAFT



ID	OD	#Teeth	Thick
35mm	54mm	50TPI	0.5mm
MBO#	- N/A		
Update#	SP988 - Micro		



ID	OD	#Teeth	Thick
35mm	53mm	70	0.5mm
MBO#	2.0.5591.060		
Update#	MN592		



ID	OD	#Teeth	Thick
35mm	49mm	72TPI	0.8mm
MBO#	- N/A		
Update#	MP897		

30mm SHAFT



ID	OD	#Teeth	Thick
35mm	50mm	72TPI	0.8mm
MBO#	- N/A		
Update#	MP896		



ID	OD	#Teeth	Thick
35mm	52mm	72TPI	0.8mm
MBO#	- N/A		
Update#	MP890		



ID	OD	#Teeth	Thick
	53mm	82	0.5mm
MBO#	2.0.5591.082		
Update#	SP528		

30mm SHAFT



ID	OD	#Teeth	Thick
35mm	53mm	82	0.8mm
MBO#	- N/A		
Update#	SP059		

35mm SHAFT



ID	OD	#Teeth	Thick
40mm	62mm	5	0.5mm
MBO#	- N/A		
Update#	SP908		



ID	OD	#Teeth	Thick
40mm	62mm	6"V"	0.5mm
MBO#	- N/A		
Update#	SP720		

*MBO is a registered trademark of MBO

MBO* Perforators - 35mm SHAFT

35mm SHAFT



ID	OD	#Teeth	Thick
40mm	61.5mm	8	0.5mm
MBO#	50210040		
Update#	SP538		



ID	OD	#Teeth	Thick
40mm	61.5mm	8	0.5mm
MBO#	- N/A		
Update#	SP228		



ID	OD	#Teeth	Thick
40mm	61.5mm	8V	0.5mm
MBO#	- N/A		
Update#	SP520		

35mm SHAFT



ID	OD	#Teeth	Thick
40mm	62mm	10	0.5mm
MBO#	50210450		
Update#	SP502		

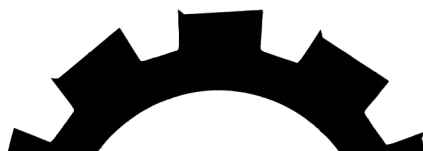

ID	OD	#Teeth	Thick
40mm	62mm	10	0.5mm
MBO#	60210260		
Update#	KP378 - Knockout		



ID	OD	#Teeth	Thick
40mm	61.5mm	12	0.5mm
MBO#	50210050		
Update#	MS292		

35mm SHAFT



ID	OD	#Teeth	Thick
40mm	61.5mm	12V	0.5mm
MBO#	50210410		
Update#	SP807		



ID	OD	#Teeth	Thick
40mm	62mm	12	0.5mm
MBO#	-NA		
Update#	SP650		



ID	OD	#Teeth	Thick
40mm	61.5mm	12	0.5mm
MBO#	- N/A		
Update#	SP808 - Reverse		

35mm SHAFT



ID	OD	#Teeth	Thick
40mm	62mm	12	1.2mm
MBO#	60210280		
Update#	KP718 - Knockout		



ID	OD	#Teeth	Thick
40mm	64mm	12	0.5mm
MBO#	- N/A		
Update#	MS296		



ID	OD	#Teeth	Thick
40mm	64mm	12	0.9mm
MBO#	60210300		
Update#	KP418 - Knockout		

35mm SHAFT



ID	OD	#Teeth	Thick
40mm	64mm	12	1.2mm
MBO#	- N/A		
Update#	KP997 - Knockout		



ID	OD	#Teeth	Thick
40mm	64mm	12	1.2mm
MBO#	- N/A		
Update#	KP518 - Knockout		



ID	OD	#Teeth	Thick
40mm	61.5mm	14	0.5mm
MBO#	50210460		
Update#	SP298		

*MBO is a registered trademark of MBO

MBO* Perforators - 35mm SHAFT

35mm SHAFT

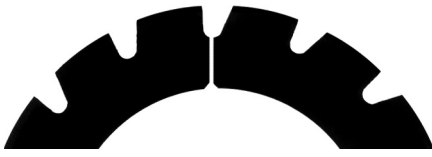

ID	OD	#Teeth	Thick
40mm	61.5mm	15	0.5mm
MBO#	50211160		
Update#	SP289		



ID	OD	#Teeth	Thick
40mm	61.5mm	15	0.5mm
MBO#	- N/A		
Update#	SP802		



ID	OD	#Teeth	Thick
40mm	61.5mm	16	0.5mm
MBO#	50210970		
Update#	SP600		

35mm SHAFT



ID	OD	#Teeth	Thick
40mm	62mm	16	0.5mm
MBO#	50211630		
Update#	SP188 - Reverse		



ID	OD	#Teeth	Thick
40mm	60mm	18	0.5mm
MBO#	50210390		
Update#	SP488		



ID	OD	#Teeth	Thick
40mm	61.5mm	18	0.5mm
MBO#	50210060		
Update#	MS293		

35mm SHAFT



ID	OD	#Teeth	Thick
40mm	61.5mm	18	0.5mm
MBO#	50210420		
Update#	SP288		

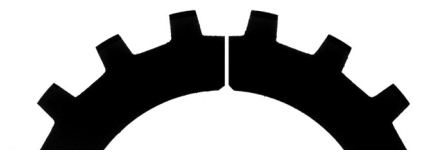

ID	OD	#Teeth	Thick
40mm	61.5mm	18	0.5mm
MBO#	5.0.5591.060		
Update#	SP640spec		



ID	OD	#Teeth	Thick
40mm	62mm	18	0.5mm
MBO#	- N/A		
Update#	SP590 - Reverse		

35mm SHAFT



ID	OD	#Teeth	Thick
40mm	64mm	18	0.5mm
MBO#	- N/A		
Update#	MS297		



ID	OD	#Teeth	Thick
40mm	62mm	18V	0.5mm
MBO#	- N/A		
Update#	SP928		



ID	OD	#Teeth	Thick
40mm	60mm	28	0.5mm
MBO#	50210210		
Update#	SP588		

35mm SHAFT



ID	OD	#Teeth	Thick
40mm	61.5mm	28	0.5mm
MBO#	50210070		
Update#	MN820		



ID	OD	#Teeth	Thick
40mm	62mm	30	0.5mm
MBO#	- N/A		
Update#	MS294		



ID	OD	#Teeth	Thick
40mm	64mm	30	0.5mm
MBO#	- N/A		
Update#	SP060		

*MBO is a registered trademark of MBO

MBO* Perforators - 35mm SHAFT

35mm SHAFT



ID	OD	#Teeth	Thick
40mm	62mm	30V	0.5mm
MBO#	- N/A		
Update#	SP321		



ID	OD	#Teeth	Thick
40mm	61.5mm	32V	0.5mm
MBO#	- N/A		
Update#	SP392		



ID	OD	#Teeth	Thick
40mm	60mm	36	0.5mm
MBO#	50210720		
Update#	SP458		

35mm SHAFT



ID	OD	#Teeth	Thick
40mm	62mm	40	0.5mm
MBO#	- N/A		
Update#	SP468		



ID	OD	#Teeth	Thick
40mm	61.5mm	45	0.5mm
MBO#	- N/A		
Update#	SP408		



ID	OD	#Teeth	Thick
40mm	60mm	48	0.5mm
MBO#	50210240		
Update#	SP333		

35mm SHAFT

Not Pictured

ID	OD	#Teeth	Thick
40mm	62mm	50TPI	1mm
MBO#	- N/A		
Update#	MP459 - Micro		



ID	OD	#Teeth	Thick
40mm	60mm	12	0.5mm
MBO#	- N/A		
Update#	SP111		



ID	OD	#Teeth	Thick
40mm	61.5mm	60V	0.5mm
MBO#	- N/A		
Update#	MS897		

35mm SHAFT



ID	OD	#Teeth	Thick
40mm	62mm	60	0.5mm
MBO#	- N/A		
Update#	MS295		



ID	OD	#Teeth	Thick
40mm	62mm	72TPI	0.5mm
MBO#	- N/A		
Update#	SP738		



ID	OD	#Teeth	Thick
40mm	60mm	80	0.5mm
MBO#	50210230		
Update#	SP999		

35mm SHAFT



ID	OD	#Teeth	Thick
40mm	62mm	80	0.5mm
MBO#	- N/A		
Update#	SP560		



ID	OD	#Teeth	Thick
40mm	59mm	80V	0.5mm
MBO#	- N/A		
Update#	SP888		



ID	OD	#Teeth	Thick
40mm	60mm	80V	0.5mm
MBO#	- N/A		
Update#	SP999spec		

*MBO is a registered trademark of MBO

MBO* Perforators - 35/40/65mm SHAFT

35mm SHAFT



ID	OD	#Teeth	Thick
40mm	60mm	100	0.5mm
MBO#	- N/A		
Update#	SP338		



ID	OD	#Teeth	Thick
40mm	61.5mm	100	0.5mm
MBO#	- N/A		
Update#	SP777		



ID	OD	#Teeth	Thick
40mm	60mm	124	0.5mm
MBO#	- N/A		
Update#	SP608		

40mm SHAFT



ID	OD	#Teeth	Thick
45mm	61.5mm	8	0.5mm
MBO#	- N/A		
Update#	SP703		

Not Pictured

ID	OD	#Teeth	Thick
45mm	61.5mm	10	0.5mm
MBO#	50210190		
Update#	SP704		



ID	OD	#Teeth	Thick
45mm	62mm	18	0.5mm
MBO#	50210190		
Update#	SP628		

40mm SHAFT

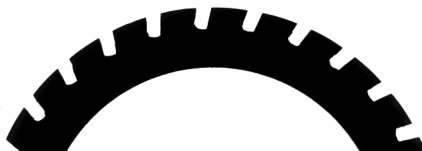

ID	OD	#Teeth	Thick
45mm	61mm	28	0.5mm
MBO#	50210370		
Update#	SP850		



ID	OD	#Teeth	Thick
45mm	60mm	48	0.5mm
MBO#	50210380		
Update#	SP728		

65mm SHAFT

Not Pictured

ID	OD	#Teeth	Thick
70mm	100mm	9	0.8mm
MBO#	- N/A		
Update#	SP088		

65mm SHAFT

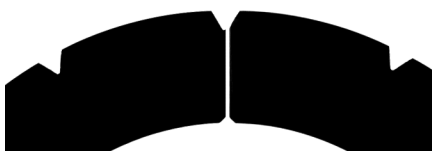

ID	OD	#Teeth	Thick
70mm	100mm	13	0.5mm
MBO#	- N/A		
Update#	SP778		

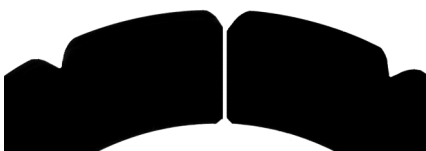

ID	OD	#Teeth	Thick
70mm	100mm	13	0.5mm
MBO#	- N/A		
Update#	SP878		



ID	OD	#Teeth	Thick
70mm	100mm	18	0.5mm
MBO#	50210341		
Update#	SP651		

65mm SHAFT



ID	OD	#Teeth	Thick
70mm	100mm	24	0.5mm
MBO#	50211130		
Update#	SP678		

Not Pictured

ID	OD	#Teeth	Thick
70mm	100mm	26	0.5mm
MBO#	50210351		
Update#	SP678		

Not Pictured

ID	OD	#Teeth	Thick
70mm	100mm	26	1.0mm
MBO#	50211300		
Update#	SP978		

MBO* Slitters & Scores - 30/35mm SHAFT

30mm SHAFT



ID	OD	#Teeth	Thick
35mm	50.8mm	-	0.8mm
MBO#	2.0.5591.080		
Update#	SS163 - Score		



ID	OD	#Teeth	Thick
35mm	52mm	-	0.8mm
MBO#	2.0.5591.020		
Update#	MS537 - Score		

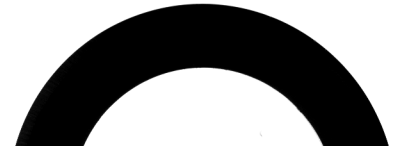

ID	OD	#Teeth	Thick
35mm	52mm	-	0.8mm
MBO#	- N/A		
Update#	SS643 - Slitter		

30mm SHAFT



ID	OD	#Teeth	Thick
35mm	53.5mm	-	0.5mm
MBO#	- N/A		
Update#	SS853 - Slitter		



ID	OD	#Teeth	Thick
35mm	54mm	-	0.5mm
MBO#	- N/A		
Update#	SS753 - Slitter		



ID	OD	#Teeth	Thick
35mm	54mm	-	0.8mm
MBO#	2.0.5591.010		
Update#	MN153 - Slitter		

30mm SHAFT



ID	OD	#Teeth	Thick
35mm	55mm	-	0.8mm
MBO#	- N/A		
Update#	MN253 - Slitter		

35mm SHAFT



ID	OD	#Teeth	Thick
40mm	58.8mm	-	0.8mm
MBO#	50210550		
Update#	SS080 - Score		



ID	OD	#Teeth	Thick
40mm	59mm	-	0.8mm
MBO#	50210550		
Update#	SS083 - Score		

35mm SHAFT

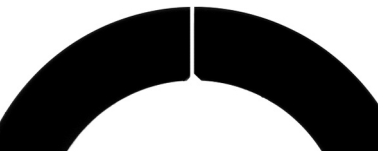

ID	OD	#Teeth	Thick
40mm	59.5mm	-	0.8mm
MBO#	50210020		
Update#	SS233 - Score		



ID	OD	#Teeth	Thick
40mm	60mm	-	0.8mm
MBO#	50210220		
Update#	SS283 - Score		



ID	OD	#Teeth	Thick
40mm	60mm	-	1.0mm
MBO#	- N/A		
Update#	SS555 - Slitter		

35mm SHAFT



ID	OD	#Teeth	Thick
	60mm	-	1.5mm
MBO#	- N/A		
Update#	SS973 - Score		



ID	OD	#Teeth	Thick
40mm	61mm	-	0.8mm
MBO#	- N/A		
Update#	MN100 - Score		



ID	OD	#Teeth	Thick
40mm	61.5mm	-	0.5mm
MBO#	50210260		
Update#	MN453 - Slitter		

*MBO is a registered trademark of MBO

MBO* Slitters & Scores - 35/40/65mm SHAFT

35mm SHAFT



ID	OD	#Teeth	Thick
40mm	61.5mm	-	1.0mm
MBO#	50210760		
Update#	MN353 - Slitter		

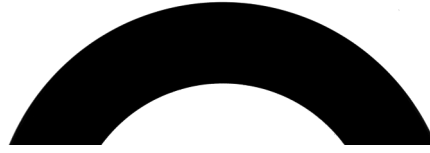

ID	OD	#Teeth	Thick
40mm	61.5mm	-	1.5mm
MBO#	50210860		
Update#	SS563 - Score		



ID	OD	#Teeth	Thick
40mm	62mm	-	0.5mm
MBO#	50210030		
Update#	MN400 - Slitter		

35mm SHAFT



ID	OD	#Teeth	Thick
40mm	62mm	-	2.0mm
MBO#	5021050		
Update#	SS005 - Slitter		



ID	OD	#Teeth	Thick
40mm	62mm	-	3.0mm
MBO#	- N/A		
Update#	SS900 - Slitter		

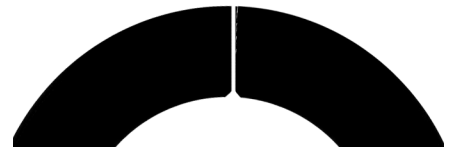

ID	OD	#Teeth	Thick
40mm	64mm	-	0.5mm
MBO#	50210480		
Update#	MN911- Slitter		

35mm SHAFT



ID	OD	#Teeth	Thick
40mm	64mm	-	2.0mm
MBO#	- N/A		
Update#	SS006 - Slitter		

40mm SHAFT



ID	OD	#Teeth	Thick
45mm	61.5mm	-	0.5mm
MBO#	50210150		
Update#	SS051 - Slitter		

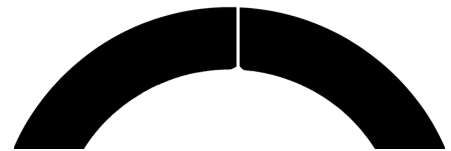

ID	OD	#Teeth	Thick
45mm	61.5mm	-	0.5mm
MBO#	- NA		
Update#	SS052 - Slitter		

40mm SHAFT



ID	OD	#Teeth	Thick
45mm	61.5mm	-	0.5mm
MBO#	50210780		
Update#	SS087 - Slitter		

65mm SHAFT

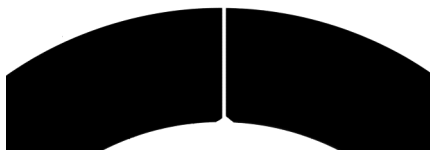

ID	OD	#Teeth	Thick
70mm	100mm	-	0.5mm
MBO#	50210331		
Update#	SS133 - Slitter		